

3-120L/SL



Carriers

2200 - 6600lb Loaders
& Skid Steers

Screening Area

17 inches x 47 inches

Weight

1025lb

S

Capacity

0.34yd³

Flow

17 gpm/us

Dimensions

A - 17 inches D - 55 inches

B - 47 inches E - 30 inches

C - 20 inches F - 28 inches

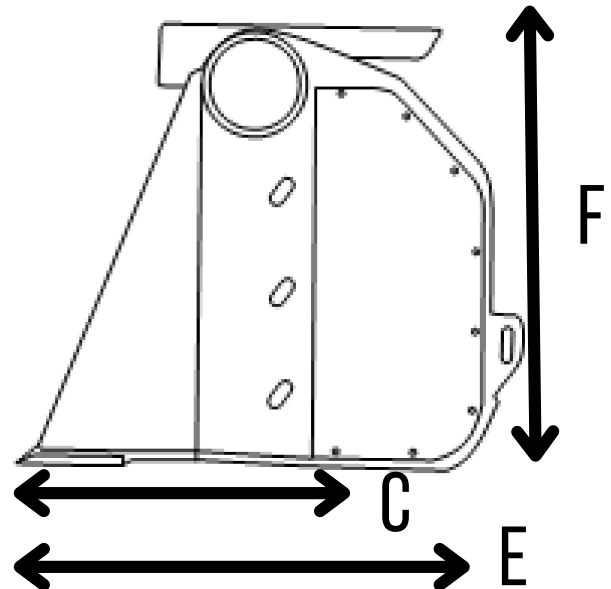
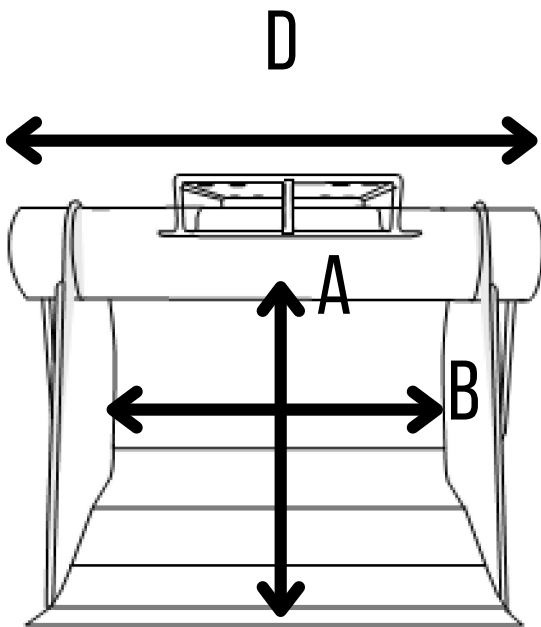

True Compact Screening
Low maintenance System
Poly-Stars screen without crushing
Non-stick floor as standard